

# SR-160 Remote Control Manual

## ※ Specifications

1. Use of KEELOQ code hopping technology by Microchip with 64 billion combinations which is guaranteed unable to break.
2. Suitable for electric lock or other remote control applications.
3. Two dry point outputs. Adjustable Toggle mode or Triggler state.
4. Transmitter (SR-30) is waterproof designed. Sliding upper case to prevent buttons being pressed accidentally, optional built-in proximity chip available to integrate with the proximity reader.
5. Special memory designed to prevent loss of data when power cut occurred.
6. Internal voltage supervisor and self-testing functions.
7. Add One New and Delete All Transmitter(SR-30) management functions.

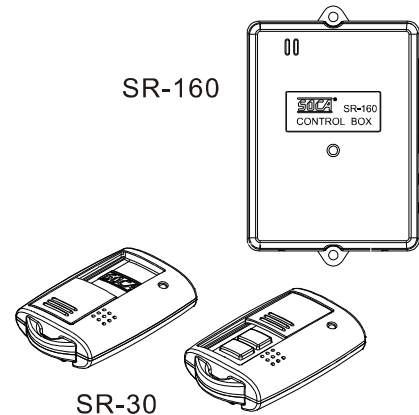

Transmitter battery : 23A12V

## ※ Specifications

Items	Models	SR-160	SR-160A	Note
Power Supply		DC12V		± 15%
Current		Maximum current 55mA Minimum current 22mA		± 5%
Output states		Toggle mode and trigger state (adjustable 0.5~9sec.)		
Contract rating		Maximum loading of 3A@30VDC		
Remote control distance		50m	100m	Open space
Frequency		315MHz	433MHz	
Operation temperature		-10°C~80°C		
Warranty		1 year		
Weight		124 g		
Dimensions		90LX60WX22D(mm)		
Capacity		Maximum 80 records of remote control data		
Case		Fireproof Polycarbonate material		

## ※ Push Buttons and Connectors

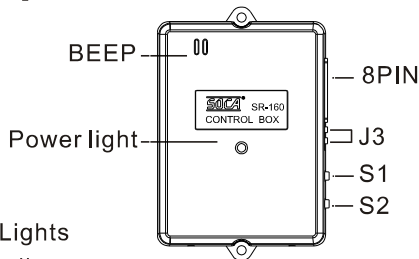
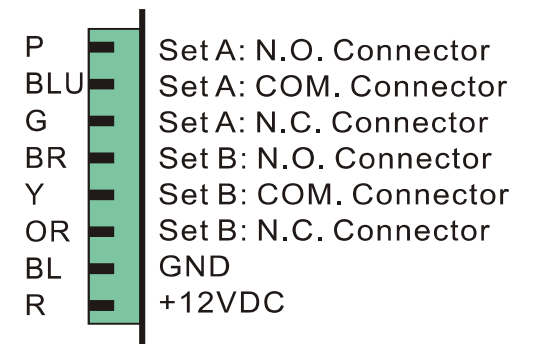

Indicator Lights  
 Red : Standby  
 Green : Connectors are operating  
 Blinking : Unregistered Transmitter

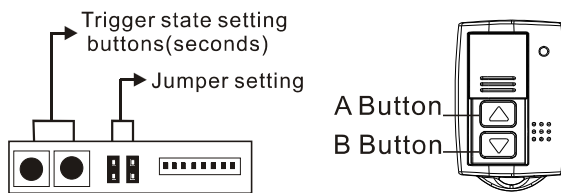

- Set A Trigger state ;Set B Trigger state (Trigger state seconds are able to set separately)
- Set A Toggle mode ;Set B Toggle mode
- Set A Toggle mode ; Set B Trigger state
- Set A Toggle state ; Set B Toggle state (Button A is ON and Button B is OFF when both set A and B are Toggle mode)

Turn off the power supply and then turn it on again to change to the new state.

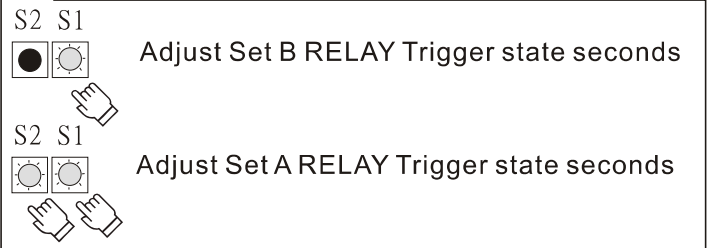

## ※ Operation instructions

1. Register controller (learning input): As shown as below

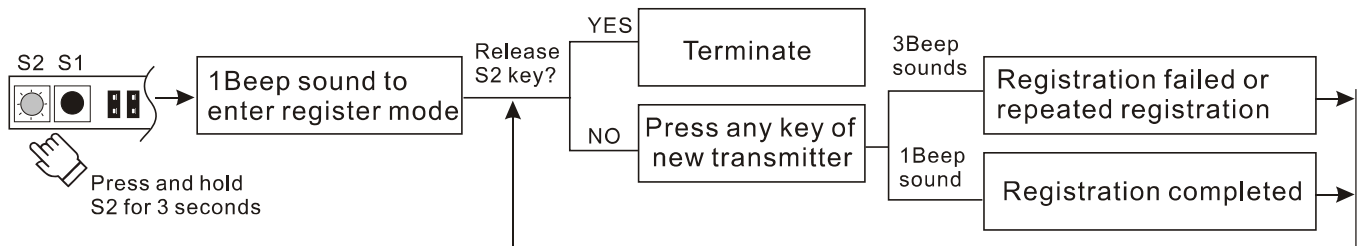

2. Setting Set B RELAY seconds: 0.5~9 seconds to integrate with electric lock for access control.

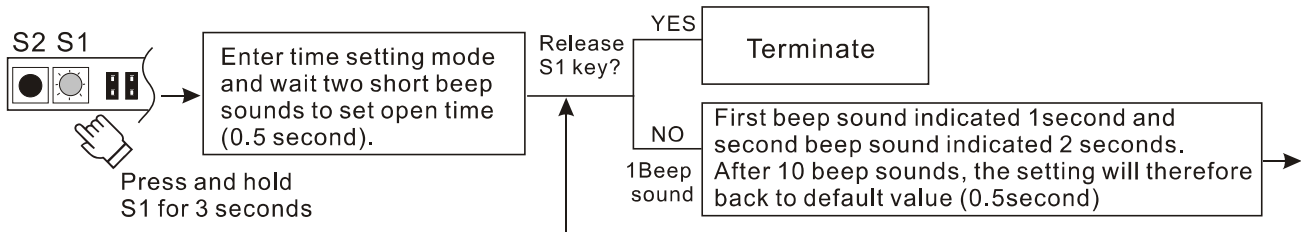

3. Setting Set A RELAY seconds: 0.5~9 seconds to integrate with electric lock for access control.

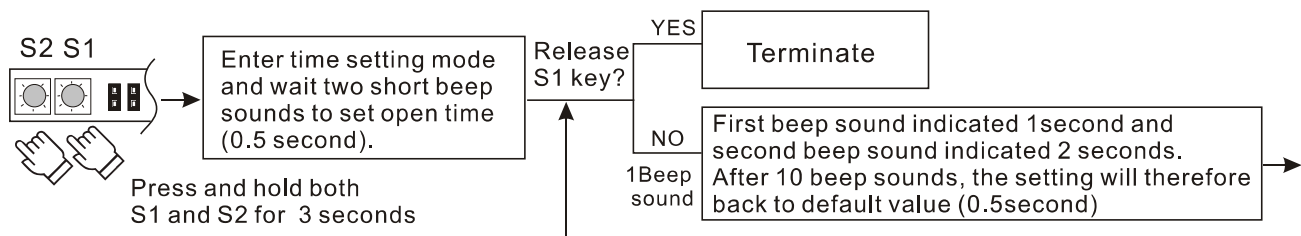

4. Deletion of all transmitters: Delete all registered transmitters and unable to retrieve.

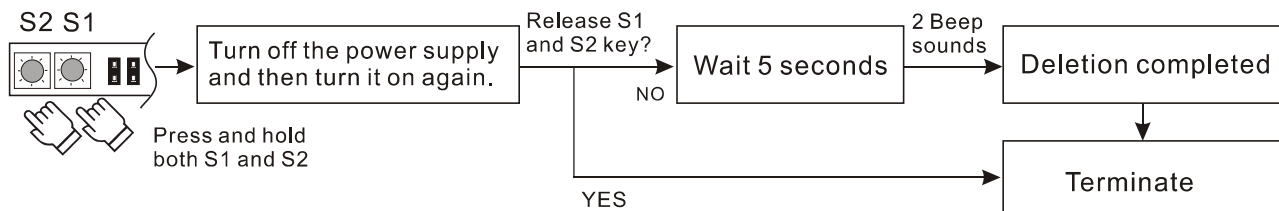

## ※ Troubleshootings

Q. Transmitter does not function when it is pressed.

A: 1. Check the power supply of the main unit.

2. Register the controller before use.

3. Replace new battery of the transmitter and try again.

4. Please press the remote control button more than 0.5 second to make sure data receiving is completed.

Q. Distance between the controller and the transmitter becomes short.

A: There are several factors that affect the distance of the controller. Please make sure none of the below factors affect the distance between the controller and the transmitter.

1. There are machines with the same frequency or wireless machines with higher frequency nearby.

2. The unit is mounted on the metal surface.

3. Low power of the unit or transmitter.

4. Too many obstacles between the unit and the transmitter.

## ※ Please Note

1. Please check the wiring of the power supply to prevent damage to the unit before installation.

2. Do not simply repair or alter the unit without our company's technicians.

3. Please instal the unit at higher place vertically pull the antenna and do not roll it.

4. The closest distance between the remote control and the reader is 30cm.