

User Manual-Smart Keybox

TUYA BLE VERSION

Kouterbaan 63 - 1840 Malderen België

T: +32 (0)52 57 43 02

E: info@lockcontrol.be

W: www.lockcontrol.be

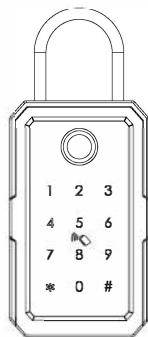

1 PACKING ACCESSORIES

Please check the packing box and accessories when you got the item in hand.

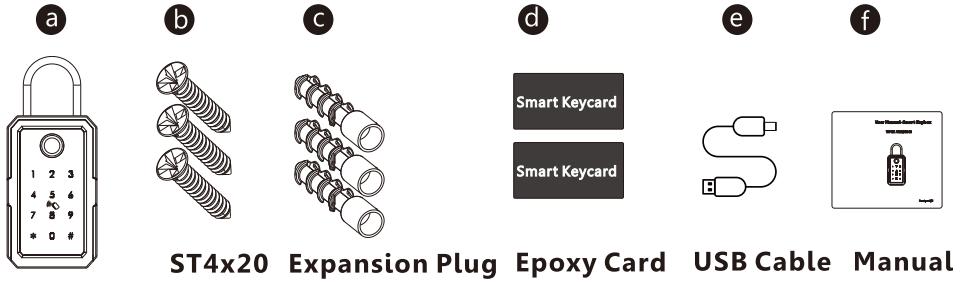

2 PRODUCT SPECIFICATION

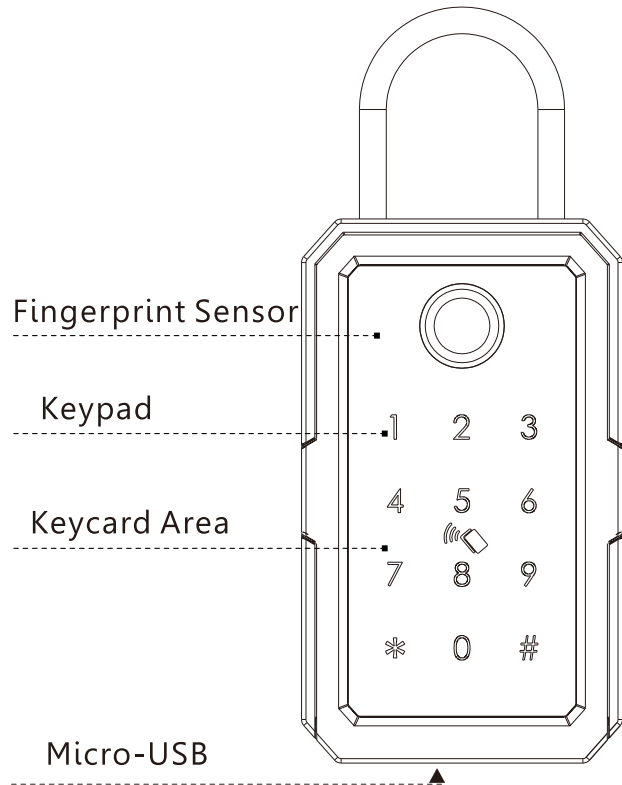

1

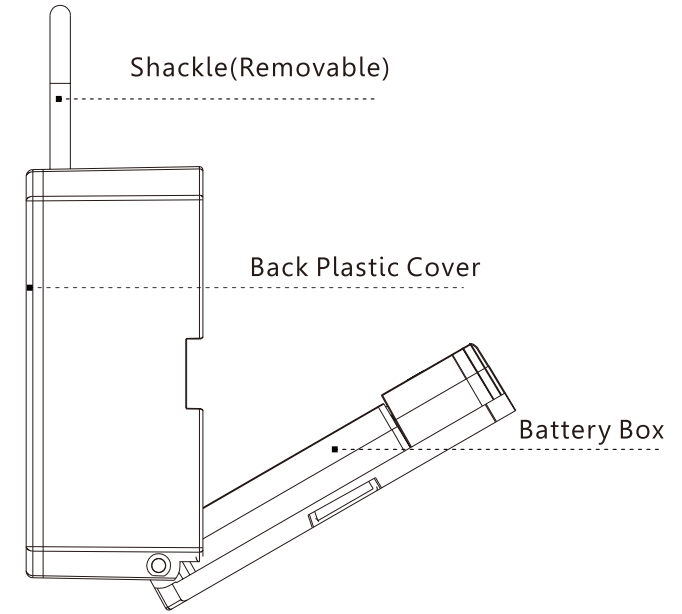

DIMENSION

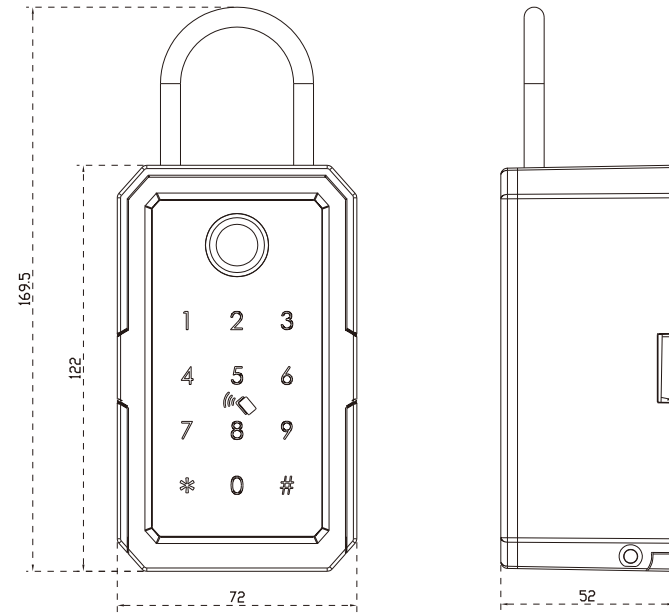

2

3 RESET TO FACTORY STATE

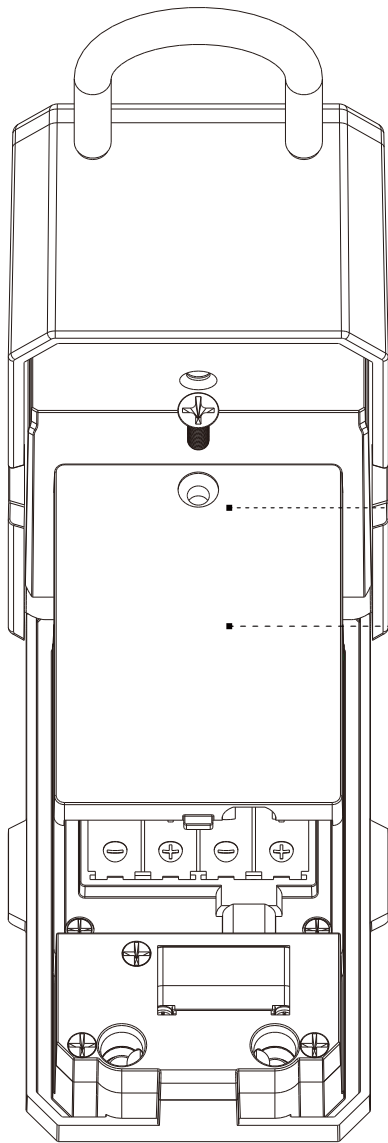

**Open the key box
Take off this screw with
one screwdriver and open
the battery box cover.**

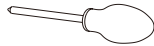

Battery Box Cover

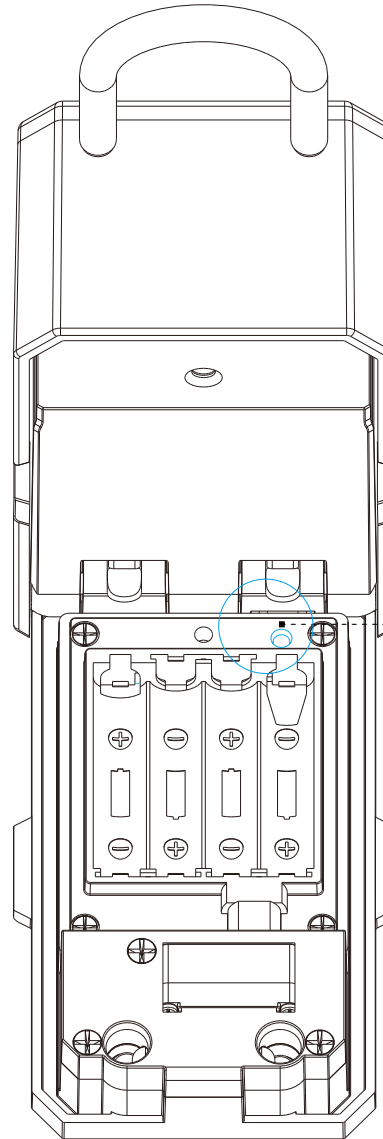

**1. Long press the reset button 2 seconds
2 Sound tip: "Please enter the
initialization password."
3 Press 000# to finish the reset.
4. Factory state password: 123456**

Reset Button

4 INSTALLATION DEMO

According to the usage condition, you can fix the key box on the wall or hang with the cylindrical lock.

4.1 INSTALL ON THE WALL

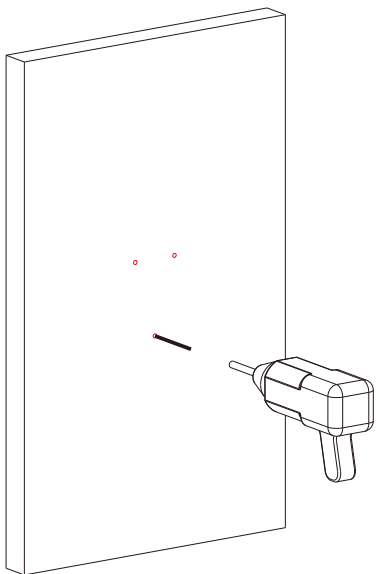

4.1.1 Drill 3 holes with the key box

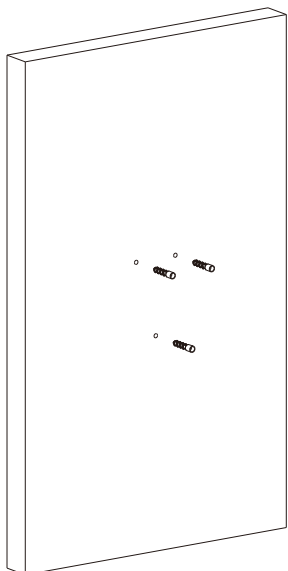

4.1.2 Punch the plastic expansion plug into the hole.

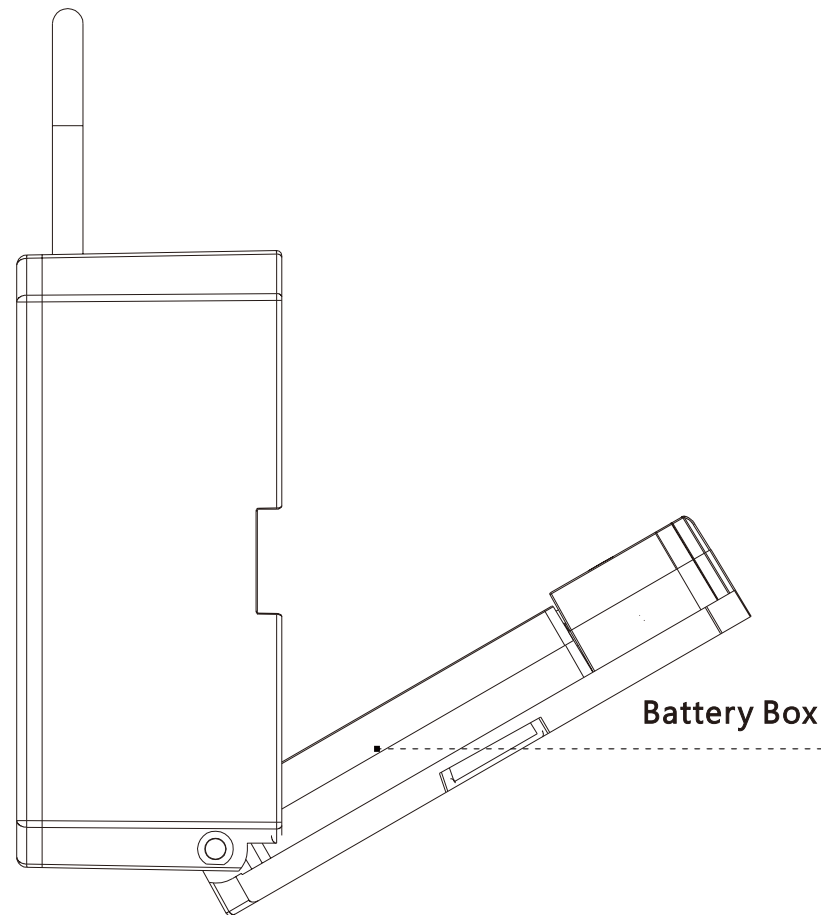

4.1.3 Fix the key box with the screws, test the lock with 4pcs AAA batteries.

4.2 HUNG WITH THE CYLINDRICAL LOCK

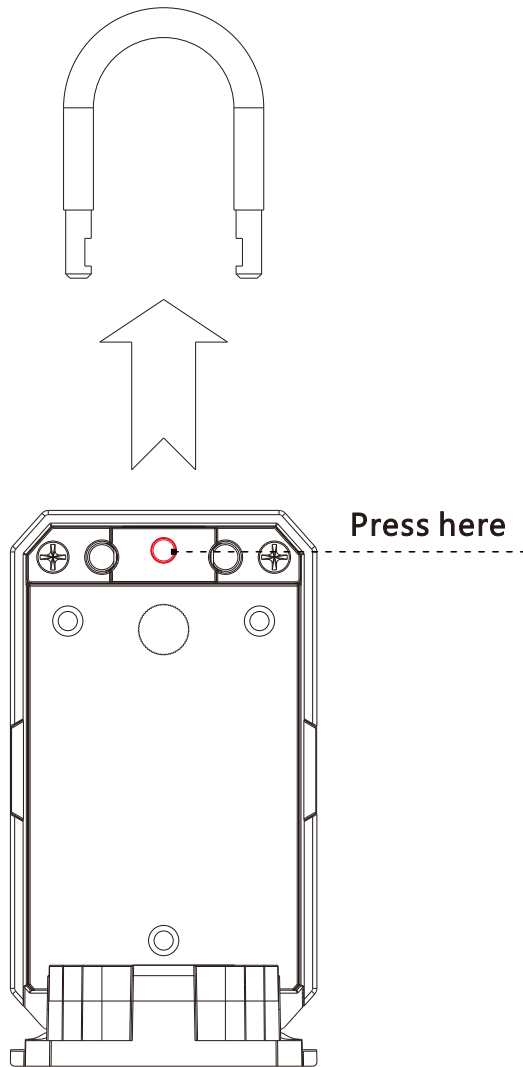

4.2.1 Press the button inside the box as above, take off the shackle.

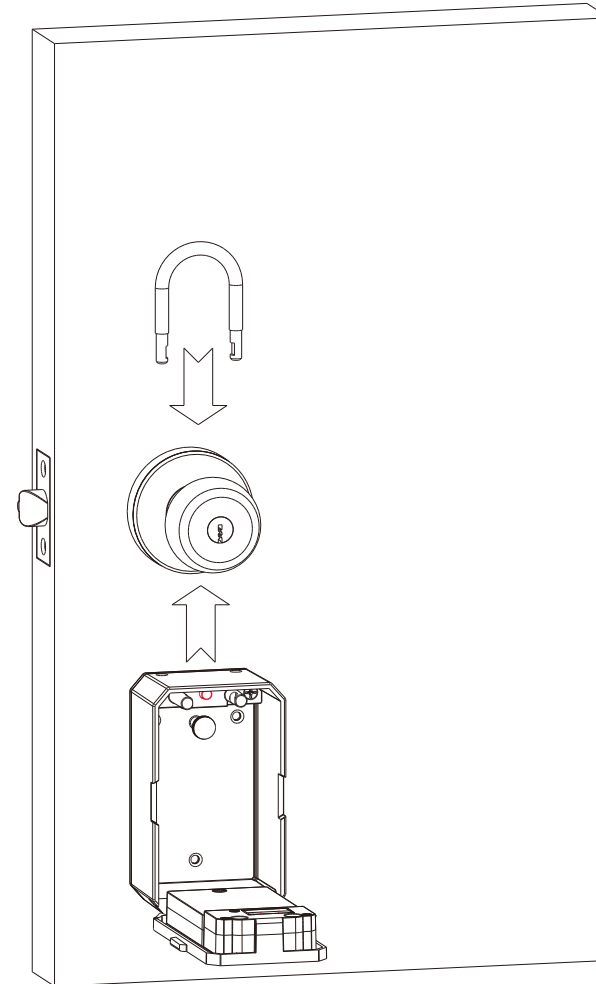

4.2.2 Insert the shackle into the hole on the box above, fasten with the cylindrical lock.

5. Tuya APP Settings

Please download the Tuya smart or Smart life on Apple store or Google play. also you can scan the QR code below to download the APP directly.



5.1 Please register one account with your E-mail or mobile number.

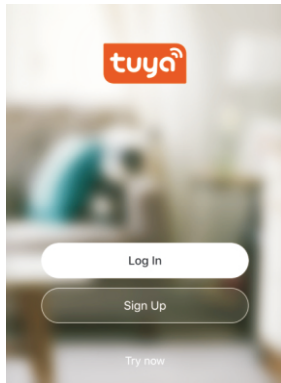

5.1.1 Sign Up

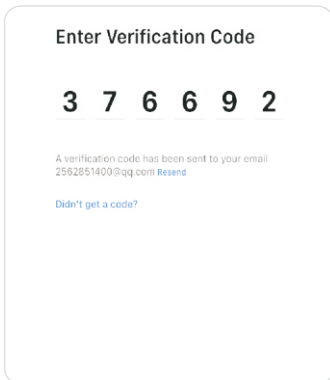

5.1.3 Enter the code sent to your mail or mobile

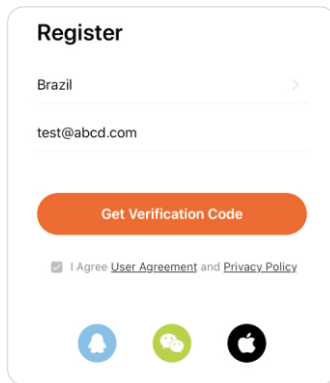

5.1.2 Enter mobile or mail Get Verification Code

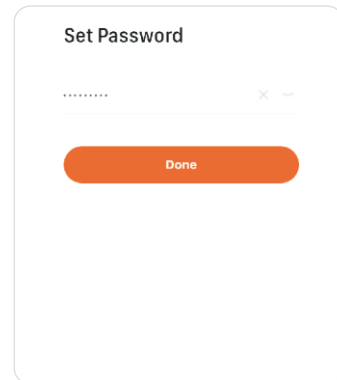

5.1.4 Set password and login

5.2 Intelligent Configuration

Please run the Tuya smart APP and choose the Bluetooth lock under the "Security&Sensors".

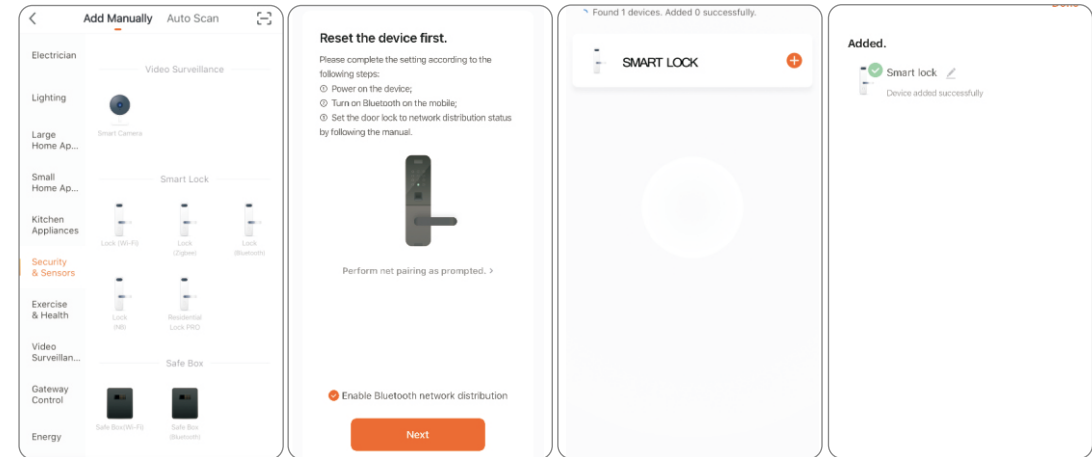

Step 1

Choose Lock (Bluetooth)

Step 2

Activate the keypad Click "Next"

Step 3

Find the lock Click the Plus

Step 4

Done

5.3 Function Description

Under Tuya smart APP interface, you can see the features for the smart locks, such as Member /unlock records and settings etc.

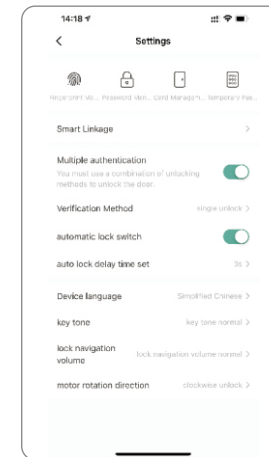
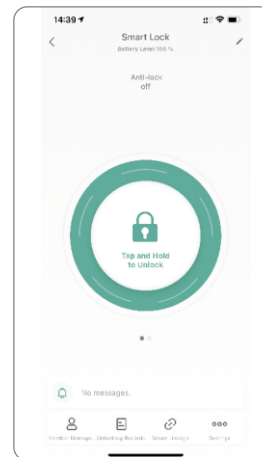

5.4 Add User Fingerprint

Under Tuya smart APP setting, you can click the fingerprint management and add the fingerprint.

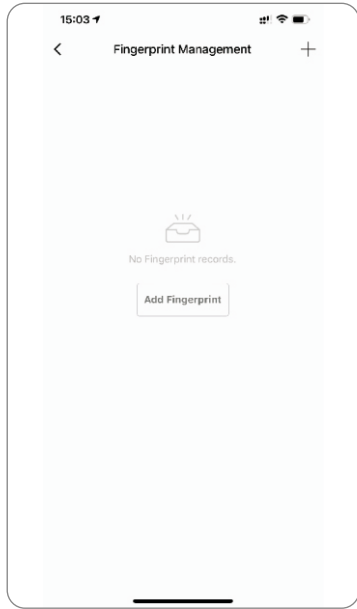

Step1:
Click Add Fingerprint

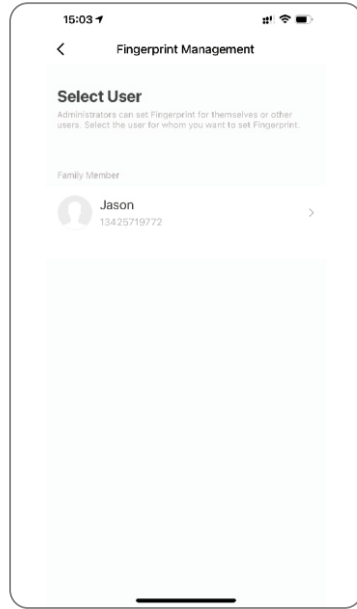

Step2 Select User

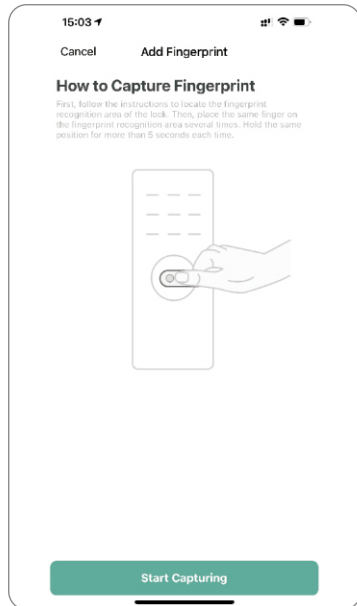

Step3:
Start Capturing

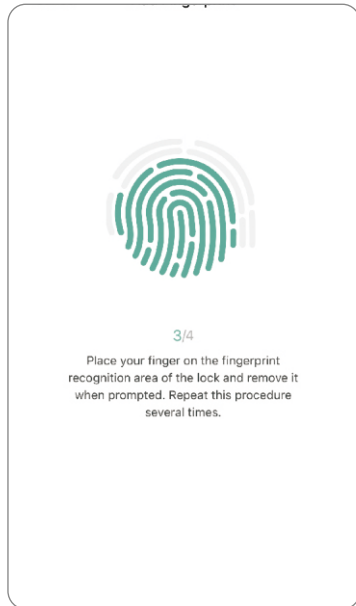

Step 4:
4 Times and done

5.5 Add User Password

Under Tuya smart APP setting, you can click the password management and add the password.

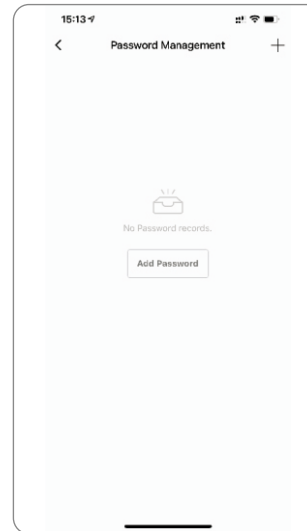

Step1:
Click Add Password

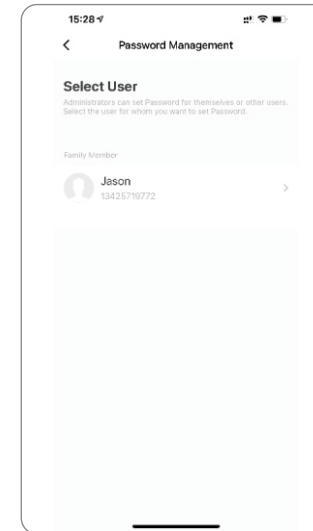

Step2:
Select User

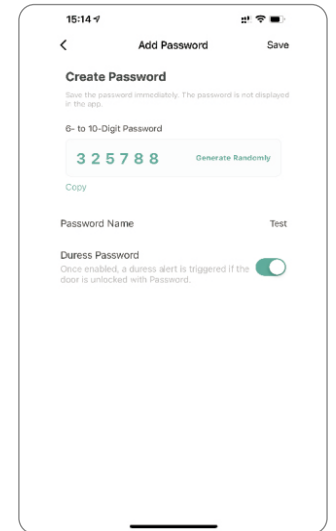

Step3:
Generate Password

5.6 Add User Card

Under Tuya smart APP setting, you can click the card Management and add the card.

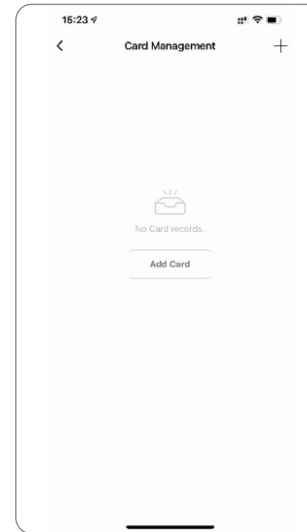

Step1:
Click Add Card

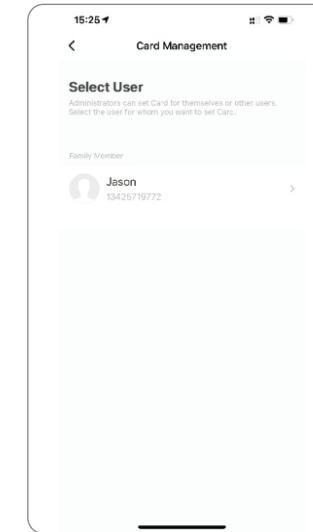

Step2:
Select User

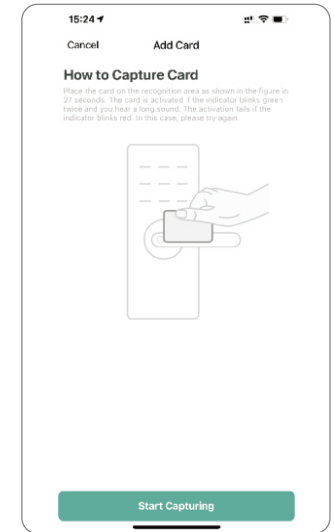

Step3:
Tap Card on the keypad induction area

5.7 Issue Dynamic or Temporary Password

Under Tuya smart APP interface, you can click the "Obtain Dynamic Password" to generate one dynamic password, which you shall use it on the lock within 5 minutes. You can issue temporary password under the Settings-Temporary Password as below:

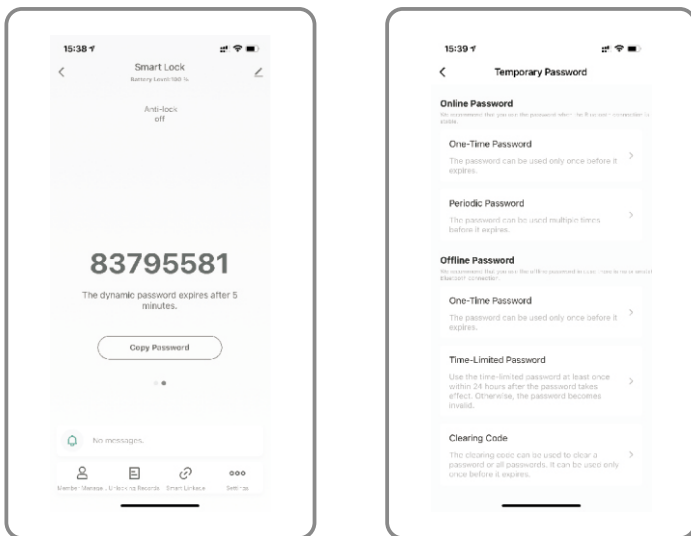

5.8 Smart Linkage and Settings

Under the settings, you can click the smart linkage for more scene and more options for the features upon the using condition.

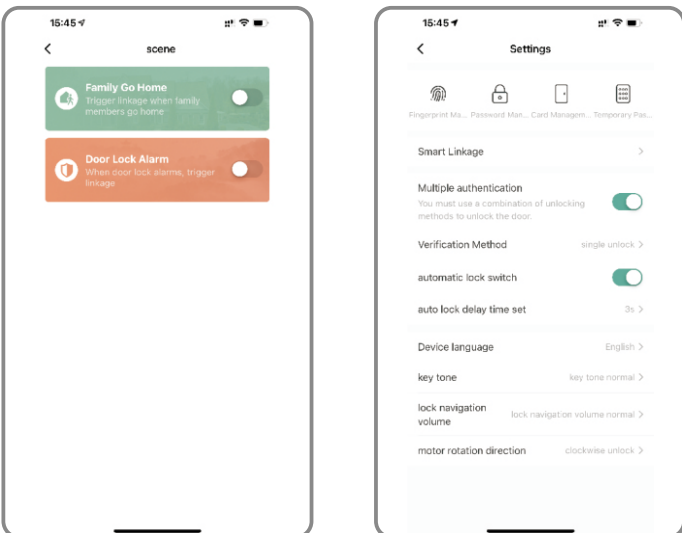

6. Sales and Service Terms

- Please read the manual carefully before use!
- Limited 1-year Electronic Warranty Limited Lifetime Mechanical and Finish Warranty
- This D3 product comes with a 1-year Limited Warranty on Electronic Parts and a Limited lifetime. Mechanical and Finish Warranty against defects in materials and workmanship under normal use to the original residential user. Proof of purchase and ownership is required for the warranty to be in effect.
- Any error or question in our manual or sales term, please feel free to contact with us.
- For any wrong operation or installation to the user, we do not responsible for the duty.
- For the damage caused by anthropic factor or inevitable reason, we do not pay for the loss or maintain for free, please check our after sale service terms.
- Please do not take apart the lock if you are not technician, if necessary, please make the operations under the guide of technician.
- Notice: there maybe a little difference for product pictures with real product, please subject to our real products.